



HINGED BASE INSTALLATION INSTRUCTIONS

Step 1 - Install the fan base brackets on the fan curb cap.

A - Place the fan base bracket against the side of the fan curb cap and position the bracket so the round hinge point is approximately 1-1/4" from the corner of the fan base. Use the etched line on the bracket for position guidance (See Figure 1). Hold the bracket against the fan base and mark through one of the oval cutouts onto the fan base side.

B - Using a 5/16" drill bit, drill through the marked spot on the fan base. Attach the fan base bracket to the fan base through the oval cutout in the fan base bracket using (1) 1/4 - 20 x 5/8" serrated truss head bolt, (1) 1/4 - 20 serrated flange nut. **IMPORTANT:** The truss head bolt should be inserted from the inside of the fan base and the serrated flange nut should be on the outside, contacting the fan base bracket. Verify the etched line on the fan base bracket is aligned with the corner of the fan base to maintain the 1 - 1/4" overhang from the fan curb cap (See Figure 1). Using the two remaining holes and the last oval cut out in the fan base bracket as a guide, drill three more holes in the fan base. Use (3) 1/4 - 20 x 5/8" serrated truss head bolts and (3) 1/4 - 20 serrated flange nuts to secure the fan base bracket to the fan base. Repeat steps A and B for the opposite side of the fan.

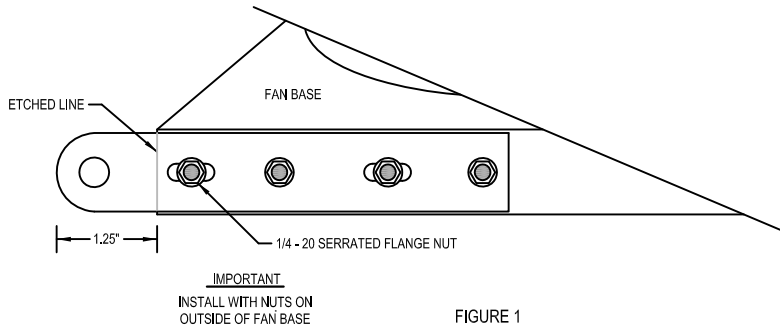

FIGURE 1

Step 2 - Fasten the curb brackets to the round hinge points on the fan base brackets.

A - Using (2) 3/8" x 1" bolts, (6) 3/8" flat washers, and (2) 3/8" nylock nuts, attach the round hinged points on the curb brackets to the round hinge points on the fan base brackets. **IMPORTANT:** The round hinge points on the curb brackets **MUST** be on the same side of the fan base brackets on each side. The curb brackets should be placed, either both on the inside or both on the outside, of the fan base brackets on each side (See Figure 2). **DO NOT** over tighten the 3/8" bolts and 3/8" nylock nuts. The bracket should move freely against one another in an up and down motion, but should not be too loose as to allow side to side movement in the hinge. (See Figure 3 for correct assembly of the hinge mechanism)

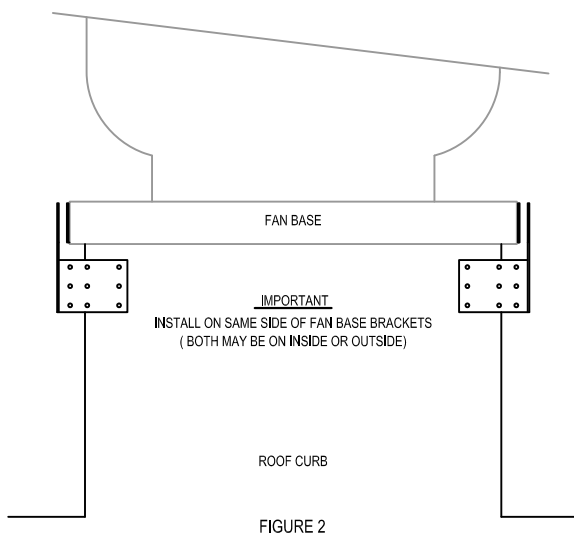
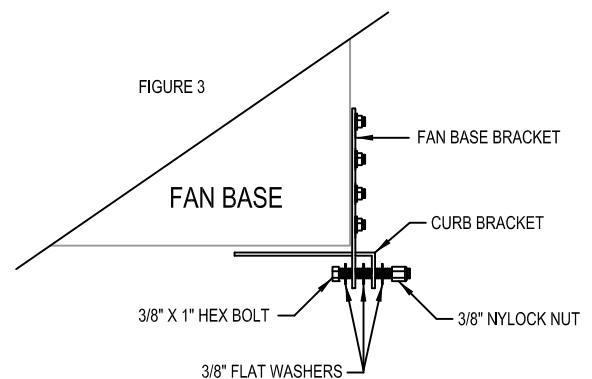

FIGURE 2



Step 3 - Center the fan on the curb from left to right.

A - Using a measuring tape, center the fan on the curb left to right in relation to the hinge brackets. Ensure the fan is square on the curb with the same clearance on the front and rear of the fan and left to right in relation to the hinge brackets (See Figure 4).

Step 4 - Attach the curb brackets to the curb.

A - While keeping the fan on center from left to right from the previous step, slide the fan forward until the curb brackets rest flush against the curb when hanging at a 90° angle from the fan base brackets.

B - Using the (12) 1/4 - 20" x 3/4 long self drilling thread cutting screws, attach the curb brackets to the curb. Depending on the offset/overhang from the fan to the curb, there should be a minimum of (6) holes in each curb bracket that will make contact with the curb for a total of (12) screws in the curb (See Figure 5).

NOTE: The hardware provided for mounting the curb brackets to the curb are self-drilling thread cutting screws. These screws should not be over tightened. Over tightening of this type screw will result in a loss of fastening power.

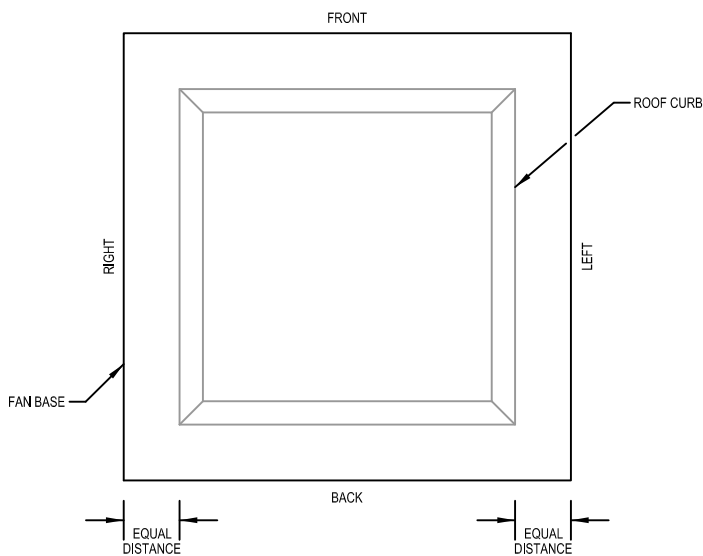

FIGURE 4

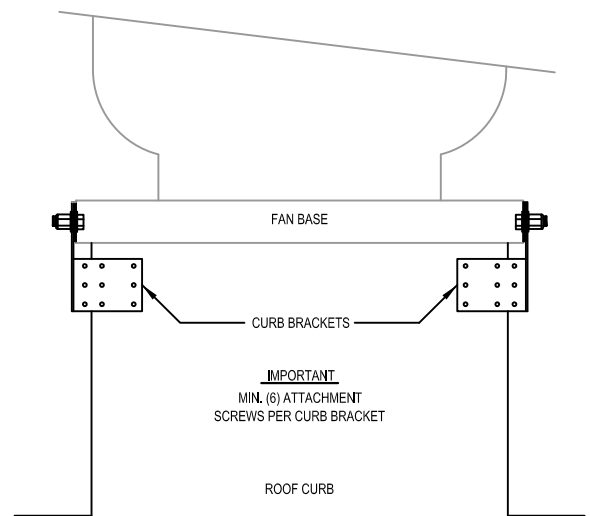

FIGURE 5

Step 5 - Install the safety restraint chains to the fan base and curb.

A - Using a 7/32" drill bit, drill a hole in the side of the curb, near the top front corner. Fasten the last link of one of the 4' restraint chains to the curb using (1) 10 - 24 x 5/8" phillips pan head bolt, (2) #10 flat washers, and (1) 10 - 24 nylock nut. Fasten the chain to the curb from the outside of the curb. Insure a washer and the nylock nut are on the inside of the curb (See Figure 6).

NOTE: Do not over tighten. Chain should be able to swing freely when fan is hinged.

B - Using (1) 10 - 24 x 5/8" phillips pan head bolt, (2) #10 flat washers, and (1) 10 - 24 nylock nut, attach the safety restraint chain to the fan base near the front corner of the fan base at the link that will stop the fan at approximately a 90° angle. Using a 7/32" drill bit, drill a hole in the fan base. Clip the excess chain off using wire cutters. Attach the chain to the fan base from the inside the fan base with the chain on the outside (See Figure 6). Repeat steps A and B for the opposite side of the fan.

NOTE: Chain may not require trimming on larger fan models.

NOTE: Do not over tighten. Chain should be able to swing freely when fan is hinged.

**** It is extremely important to use both safety restraint chains to avoid damage to the fan base when hinged. ****

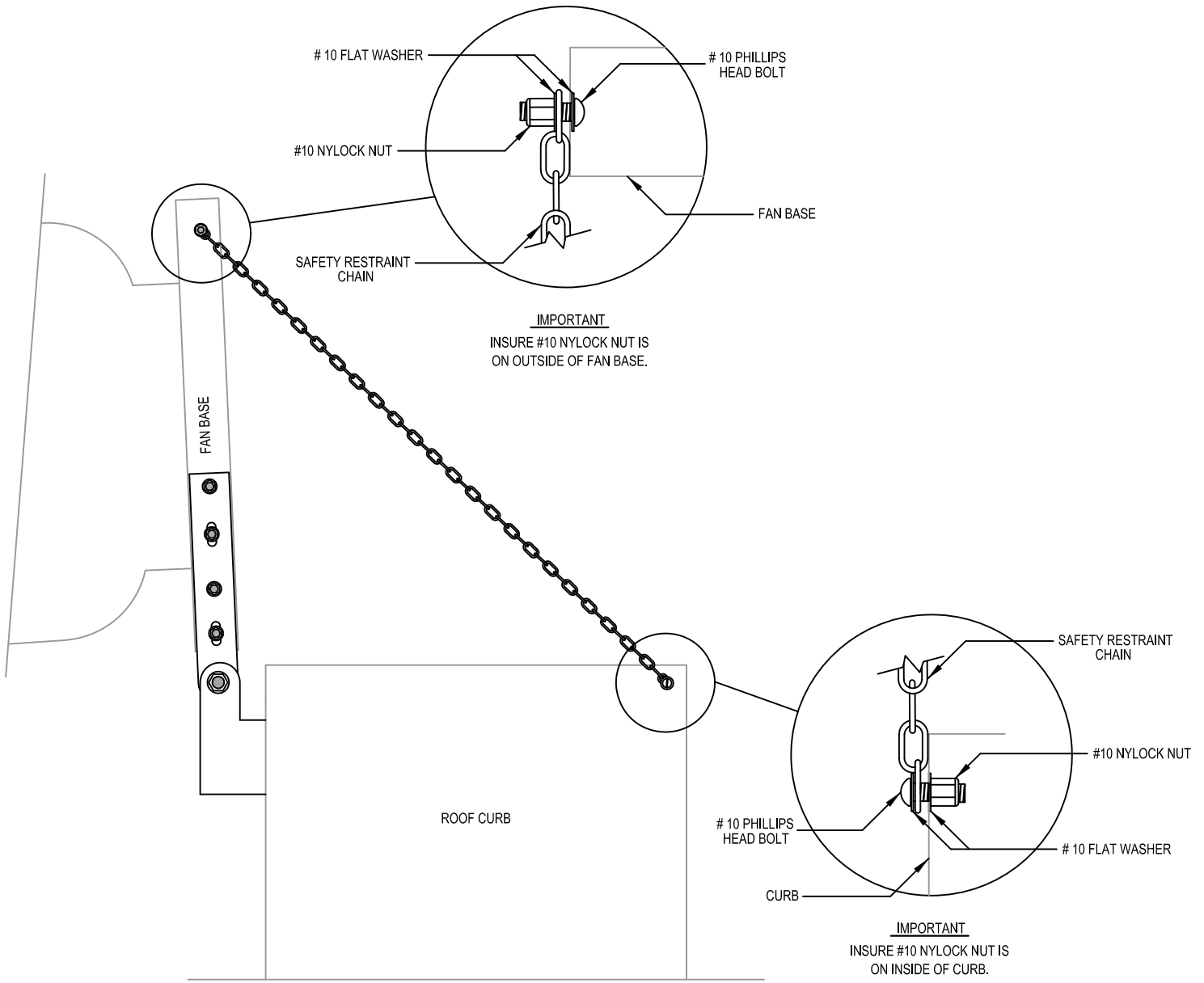
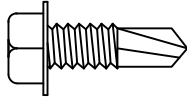
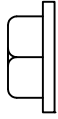

FIGURE 6

HARDWARE LIST



(12) 1/4 - 20 x 3/4 Serrated Hex Washer Unslotted Self Drilling #3 Pt.



(8) 1/4 - 20 Serrated Hex Flange Nut

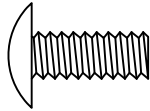

(8) 1/4 - 20 x 5/8 Slotted Truss Serrated MS Full Thread



(4) 10 - 24 x 5/8 Phillip Pan MS

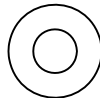

(8) #10 Flat Washer



(4) 10 - 24 Nylon Insert Lock Nut

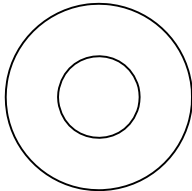

(6) 3/8 Flat Washer

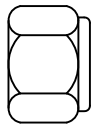

(2) 3/8 - 16 Nylon Insert Lock Nut

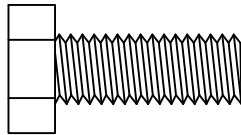

(2) 3/8 x 1 Hex Head Cap Screw Gr 5

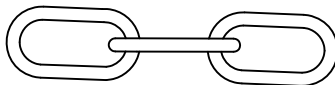

(2) #3 Double Loop Chain Pre Cut 4'

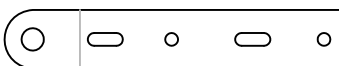

(2) Fan Base Brackets

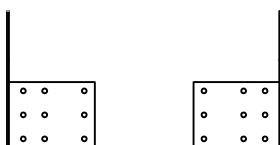

(2) Curb Brackets